

Steps:

- 1) Connect base to post, using bolt.
- 2) Route cord from table top through post and base.
- 3) Connect table top to post with fixed brackets, using black bolts.

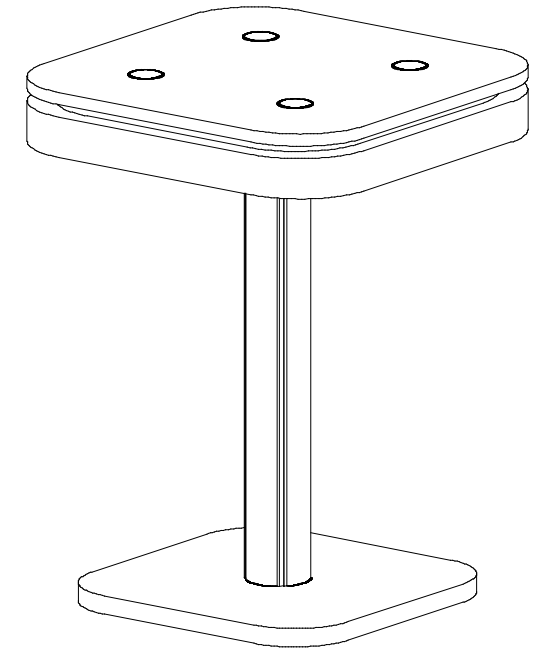
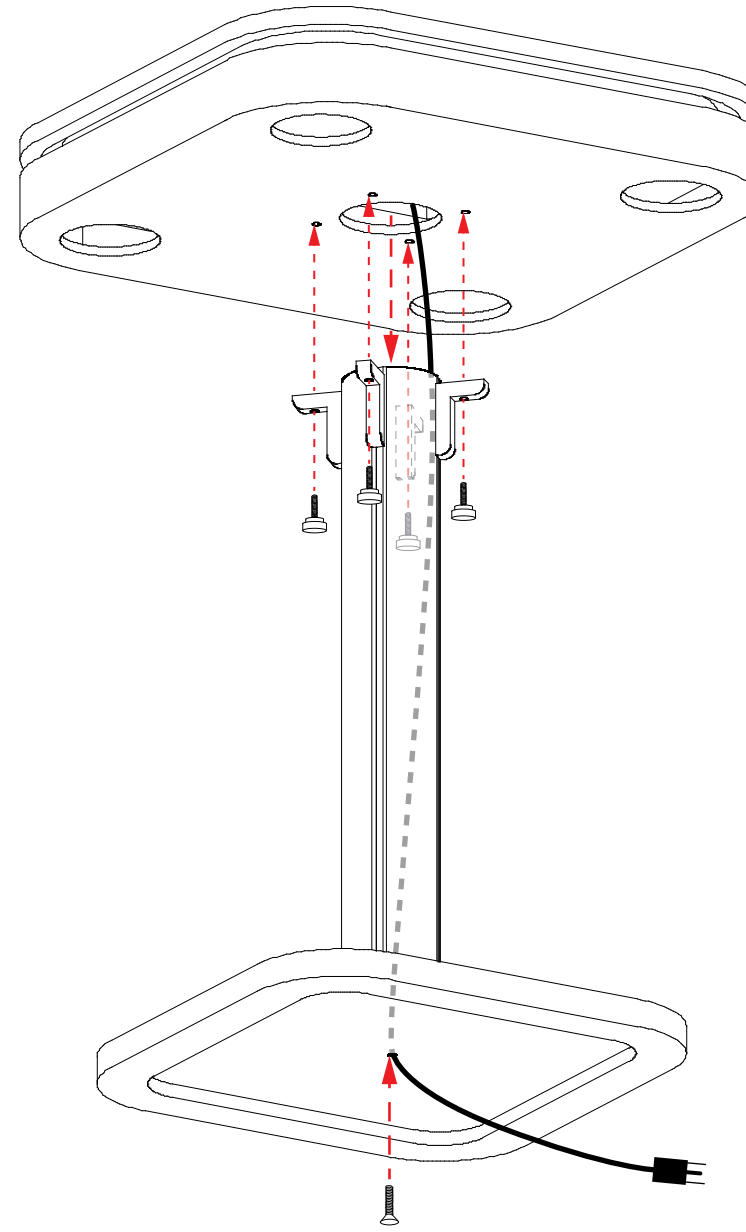
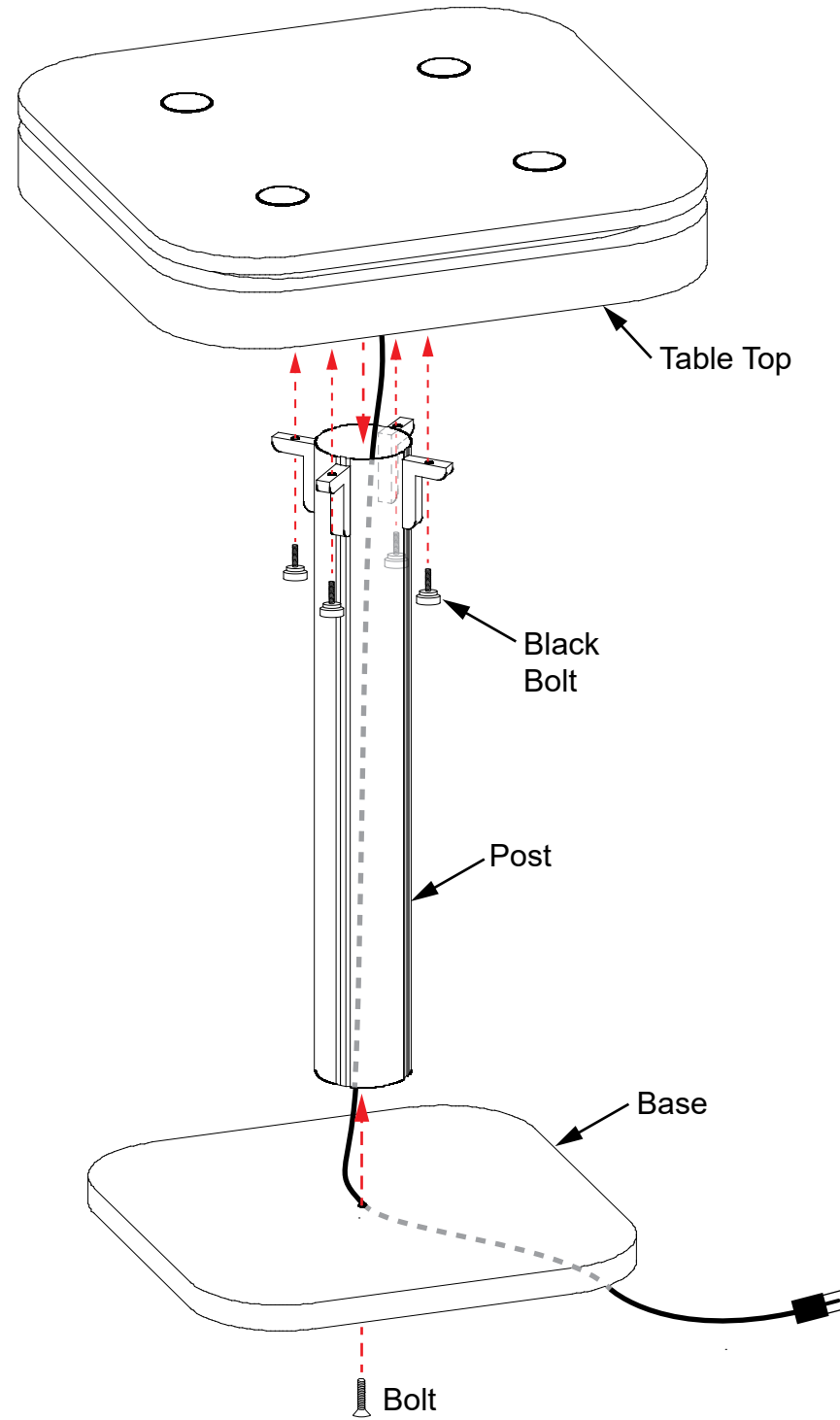

Completed Assembly

SETUP INSTRUCTIONS

General Setup Instructions

- Read entire setup instruction manual prior to unpacking parts and pieces.
- The setup instructions are created specifically for this configuration.
- Setup instructions are laid out sequentially in steps, including exploded views with detailed explanation for assembly.

Cleaning & Packing

- For Cleaning Metal, Plex, & Laminate Parts: Use a **MILD NON-ABRASIVE** cleanser and soft cloth/paper towel to clean all surfaces.
- Keep exhibit components away from heat and prolonged sun exposure. **Heat and UV exposure will warp and fade components.**
- Retain all provided Packing Materials. All provided packing materials are for ease of repacking & component protection.

Disassembly

- For loss prevention, tighten all set screws and locks during disassembly.

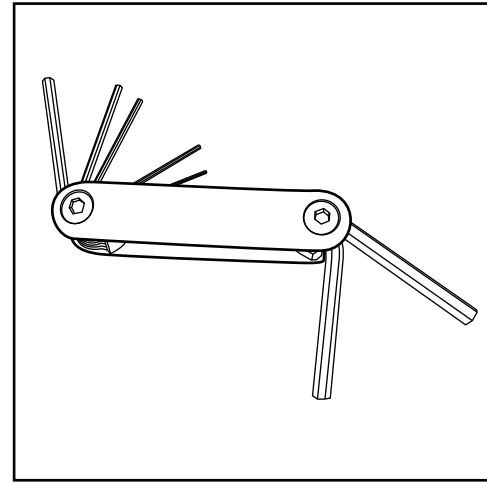

Hex Tool - Essential for Assembly

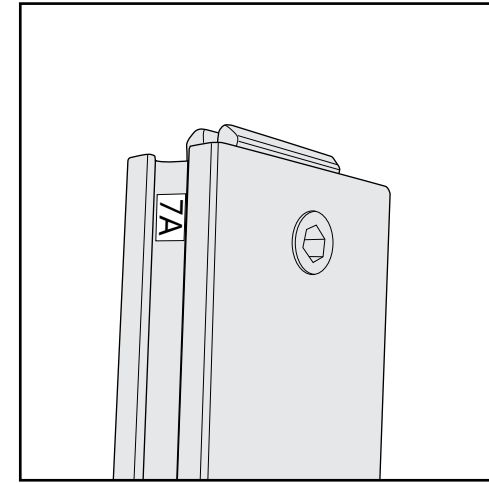

Part Identification - Numbering



Spline Connection

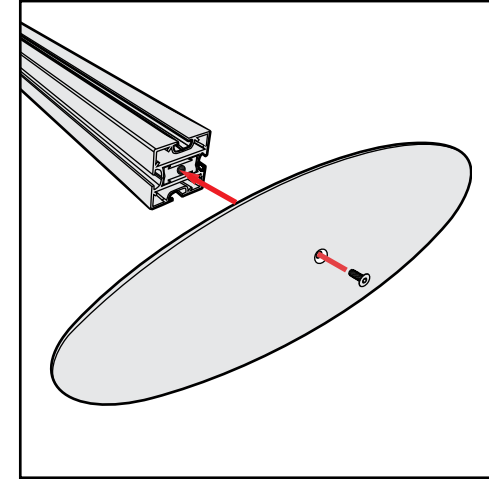

Base Plate & Extrusion Connection



Extrusion & Lock Connection

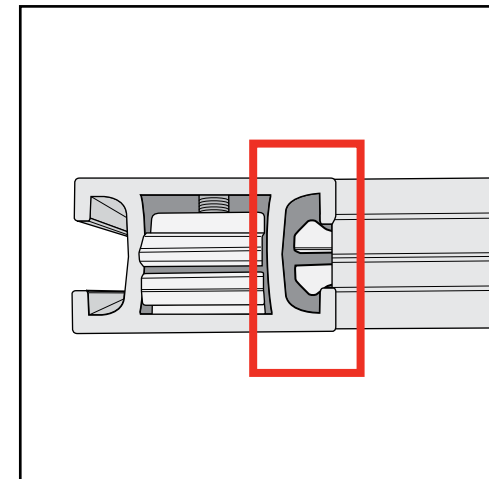

Engaged Lock



WARNING



DO NOT USE POWER TOOLS



LADDERS OR LIFTS
MAY BE REQUIRED



ALL CONNECTIONS MUST
BE TIGHTLY SECURED

*Retain all packing materials.
DO NOT DISCARD.*

CRATE PACKING

MOD-1458